

Solar Light Company, Inc. has been the foremost name in light sciences since we invented the world's first Solar Simulator in 1967. Our state of the art single output **LS1000-Series** and **16S-Series Solar Simulators** produce solar UV radiation in the 290-400nm range, and can be quickly and easily configured by the user to provide UVA only, UVB only, UVA+B, or full spectrum sunlight optionally. These precision research-grade instruments are specifically designed for the pre-irradiation step during in vitro broad spectrum sunscreen testing, and are fully compliant with the most current FDA and ISO requirements. Everything required for instant testing right out of the crate is included direct from the factory: Solar Simulator, Dose Controller / Radiometer, NIST-traceable Erythema and UVA Sensors, molded or sandblasted PMMA Plates, and all related accessories!



LS1000-Series

- > 95% Uniformity, with 98% Uniformity available in beam's central usable area
- Square Beam Models available in 4" (10 cm) and 6" (15 cm) single port outputs
- 4" (10 cm) models provide simultaneous pre-irradiation of up to 4 PMMA plates in ~23 minutes
- 6" (15 cm) models provide simultaneous pre-irradiation of up to 9 PMMA plates in ~23 minutes
- Collimated Output Provides up to 14" (35.5 cm) Working Distance

16S-Series

- > 90% Uniformity in beam's usable area
- Round Beam Model available in 3" (7.5 cm) single port output
- Provides pre-irradiation of 1 PMMA plate in ~23 minutes
- Focused Output provides up to 18" (46 cm) working distance

Advantages

- Standard and Customizable Simulators validated to comply with FDA, ISO, and COLIPA Standards
- CE Compliant
- Prepackaged Kits include Dose Controller / Radiometer, NIST-traceable Erythema and UVA Sensors, molded or sandblasted PMMA Plates, and all related accessories required for immediate testing
- Temperature rise of the irradiated PMMA plate is <0.2 °C.
- Custom-Designed Spectra available
- High performance fused silica optical components included
- Excellent long-term stability
- Easy to use Intensity and Uniformity Measurement System
- Automatic shutter with remote control connection Included
- High efficiency Switching Power Supply with adjustable output for variable lamp power included
- Optional Air Mass 0 and 1.5 Spectra from 250-2500nm available
- Optional Visible Light Only output available
- Optional Light Attenuation Screens available
- Optional Validation available





Solar Light's Turnkey Testing Kits include Simulators, Dose Controllers, Radiometers, Sensors, PMMA Plates and Accessories so you can start testing instantly!

Turnkey Kits For Pre-Irradiation of PMMA Plates used in In-Vitro Broad Spectrum Testing

Our prepackaged kits combine these state of the art Solar Simulators with our innovative Automatic Dose Controllers, advanced Data Logging Radiometers, NIST-traceable Sensors, and other hardware to allow for instant testing right out of the crate. Typical kits include:



Sophisticated Automatic Dose Controllers measure the spectral response following the Erythema Action Spectrum and UVA Spectrum to allow accurate dose control when measuring SPF values. The 7-inch (17.8 cm) touch sensitive screen allows the user to follow intuitive menus and makes it quick and easy to set control parameters.



Advanced NIST-Traceable Sensors for accurate measurement of biologically-weighted SUV as required for FDA compliance and UVA as required for ISO testing. Over 130+ different sensor models available for custom configurations.



Helioscreen Heliplates HD6 molded and SB6 sandblasted PMMA Plates specifically designed for SPF determination are available in our kits. These set the industry standard for quality and reproducibility of valid results.



Laboratory Scissor Jacks with 5.5"x5.5" (14cm x 14cm) surface allow for height adjustment from 2.75" to 10.25" (7cm to 26cm) for accurate specimen setup.



SPECIFICATION	16S-300-009	LS1000-4S-009	LS1000-6S-009
Output Beam Size	3" (7.5 cm) Round	4" (10 cm) Square	6" (15 cm) Square
Beam Orientation	Vertical Downward, Vertical Upward, or Horizontal (please specify at order)	Vertical Downward, Vertical Upward, or Horizontal (please specify at order)	Vertical Downward, Vertical Upward, or Horizontal (please specify at order)
Lamp Type	Xenon Short Arc	Xenon Short Arc	Xenon Short Arc
Lamp Wattage (Nominal)	300W	1000W	1000W
Beam Uniformity	±10%	±5%	±5%
Collimation	N/A	±1.5-3 Degree Half Angle (For All Models)	±1.5-3 Degree Half Angle (For All Models)
Spectral Match Classification	A (IEC 60904-9 2007)	A (IEC 60904-9 2007)	A (IEC 60904-9 2007)
	A (JIS C 8912)	A (JIS C 8912)	A (JIS C 8912)
	A (ASTM E927 - 05)	A (ASTM E927 - 05)	A (ASTM E927 - 05)
Temporal Instability Classification	A (IEC 60904-9 2007)	A (IEC 60904-9 2007)	A (IEC 60904-9 2007)
	A (JIS C 8912)	A (JIS C 8912)	A (JIS C 8912)
	A (ASTM E927 - 05)	A (ASTM E927 - 05)	A (ASTM E927 - 05)
Uniformity Classification	B (IEC 60904-9 2007)	B (IEC 60904-9 2007)	B (IEC 60904-9 2007)
	B (JIS C 8912)	B (JIS C 8912)	B (JIS C 8912)
	B (ASTM E927 - 05)	B (ASTM E927 - 05)	B (ASTM E927 - 05)
Light Ripple	< ±2% rms	< ±2% rms	< ±2% rms
Working Distance	~18" (46 cm)	5.0" ±2.0" (12.7 cm +/- 5.2 cm)	5.0" ±2.0" (12.7 cm +/- 5.2 cm)
Long Term Drift (<4 Hours)	<0.1%	<0.1%	<0.1%
Power Limit	Factory Set Limit is 320 watts	Factory Set Limit is 1,500 watts max	Factory Set Limit is 1,500 watts max
Operating Temperature	32°F to 95°F / 0°C to +35°C	32°F to 95°F / 0°C to +35°C	32°F to 95°F / 0°C to +35°C
Storage Temperature	-4°F to 185°F / -20°C to +85°C	-4°F to 185°F / -20°C to +85°C	-4°F to 185°F / -20°C to +85°C
Humidity	0 to 95% non-condensing	0 to 95% non-condensing	0 to 95% non-condensing
Cooling	Forced air	Forced air	Forced air
Medical Safety Certifications	EN61010-1 Laboratory, EN60335 Appliances, IEC60601-1 Medical		
EMI/EMC	EN55011 Emissions, IEC60601-1-2:2001, 2nd Rev 2 Medical, IEC61000-3-2 Harmonic, IEC61000-3-3 Flicker, IEC61000-4-2 ESD, IEC61000-4-3 Radiated, IEC61000-4-4 EFT, IEC61000-4-5 Surge, IEC61000-4-6 Conducted, IEC61000-4-11 Voltage Dip, IEC61000-4-8 Magnetic Field		
Weight	10.5 lbs. (4.8 kg.)	40 lbs. (18.2 kg.)	45 lbs. (20.5 kg.)

Part Number: 210067

Revision Level: A

Specifications subject to change without notice.



Compliant



Compliant



ISO 24443 Compliant



FDA In Vitro SPF



COLIPA Compliant



Boots Star Rated



Compliant



Compliant

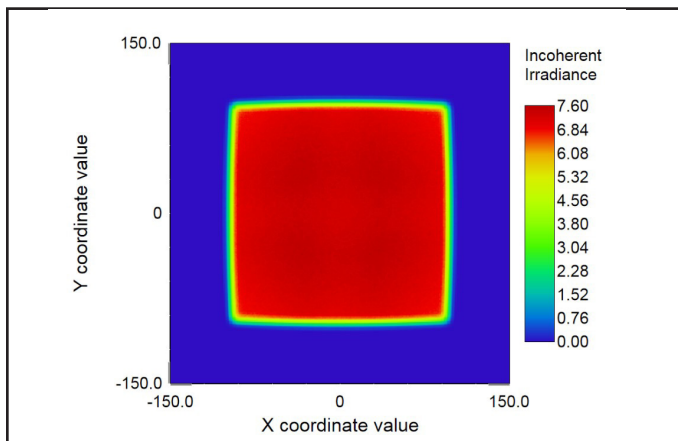

Typical LS1000 False Color Irradiance Map (250mm working distance)

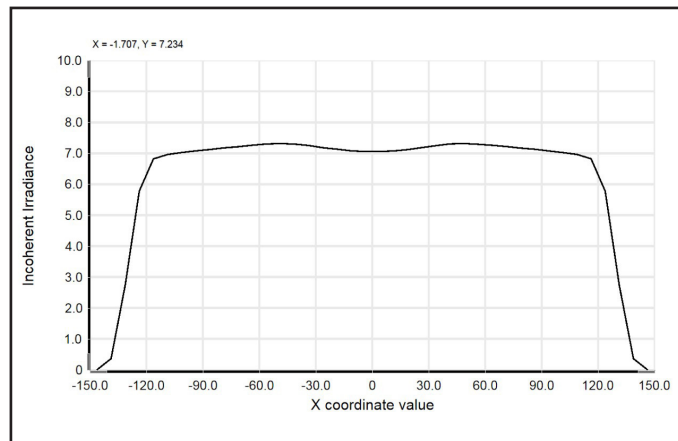

Typical LS1000 Corner To Corner Irradiance Line Profile

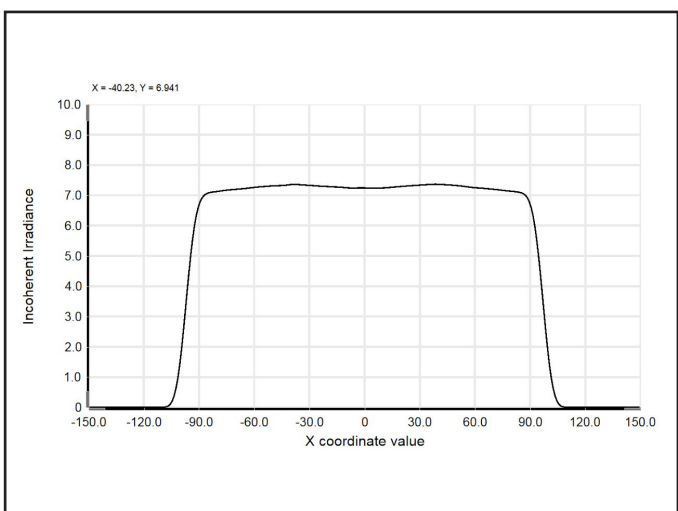

Typical LS1000 Center Column Irradiance Line Profile

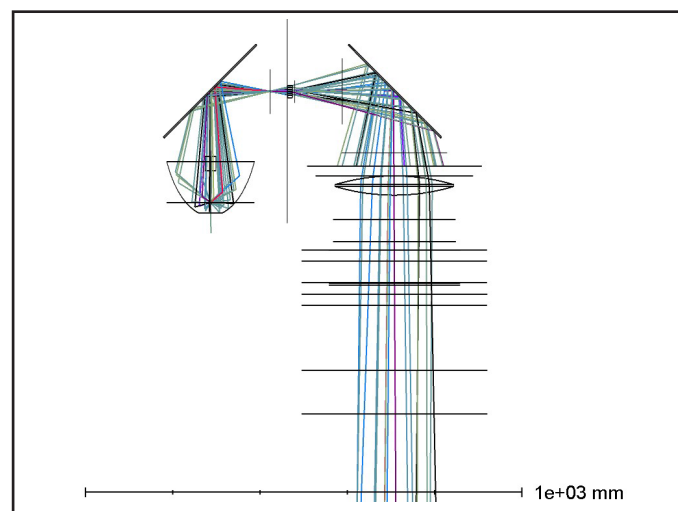

Typical LS1000 System Ray Diagram (250mm working distance)

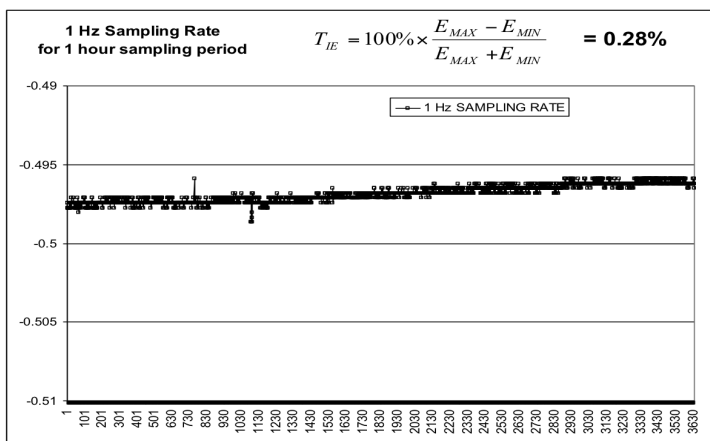

Typical LS1000 Simulator Short-Term Drift

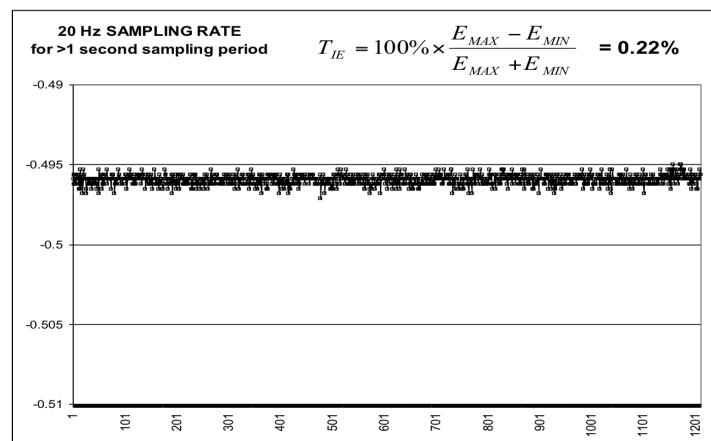

Typical LS1000 Simulator Long-Term Drift



Solar Light SPF-290AS UV Transmittance Analyzer



For related applications, Solar Light also offers our state of the art SPF-290AS UV Transmittance Analyzer complete with computer, monitor, software, and validation kit, which meets FDA and ISO24443. Please consult the factory for more details.

WinSPF™ Software

- Automatically loads Colipa spreadsheet during installation for use with Colipa's In-Vitro UVA guidelines.
- Now includes calculations and displays screens in compliance with AATCC-183 fabric test method.
- Now includes calculations and displays screens in compliance with AAS/NZS 4399 fabric test method.
- Now includes UVA Protection Factor and Erythral Protection Factor calculations.
- Updated Help System
- Comes with audio visual training aids; intuitive computerized modules deigned to assist the operator with everything from spreading a sample to routine maintenance.

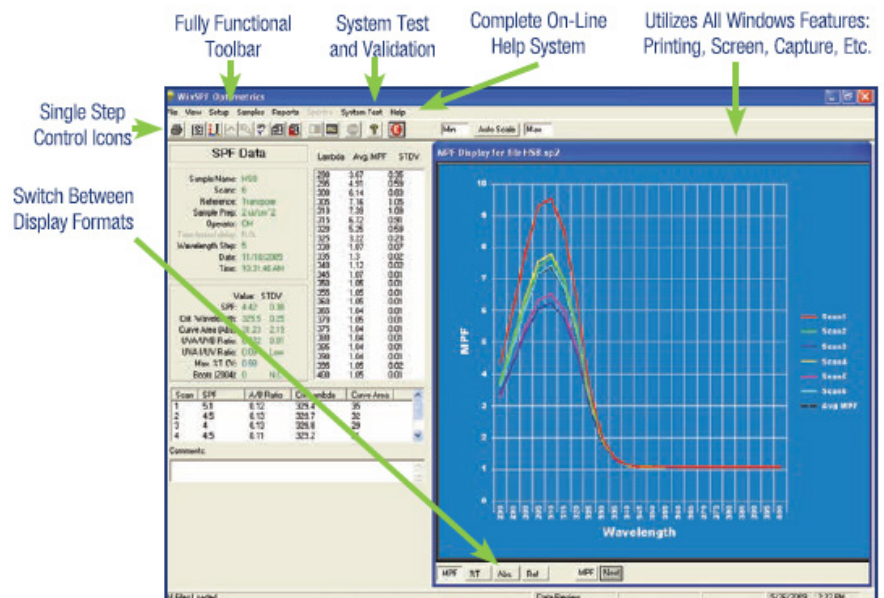

Data can be acquired in approximately 20 seconds. Results displayed in easy to read format.



16S-Series 3 Inch (7.5 cm) UV Solar Simulator Outline Drawing

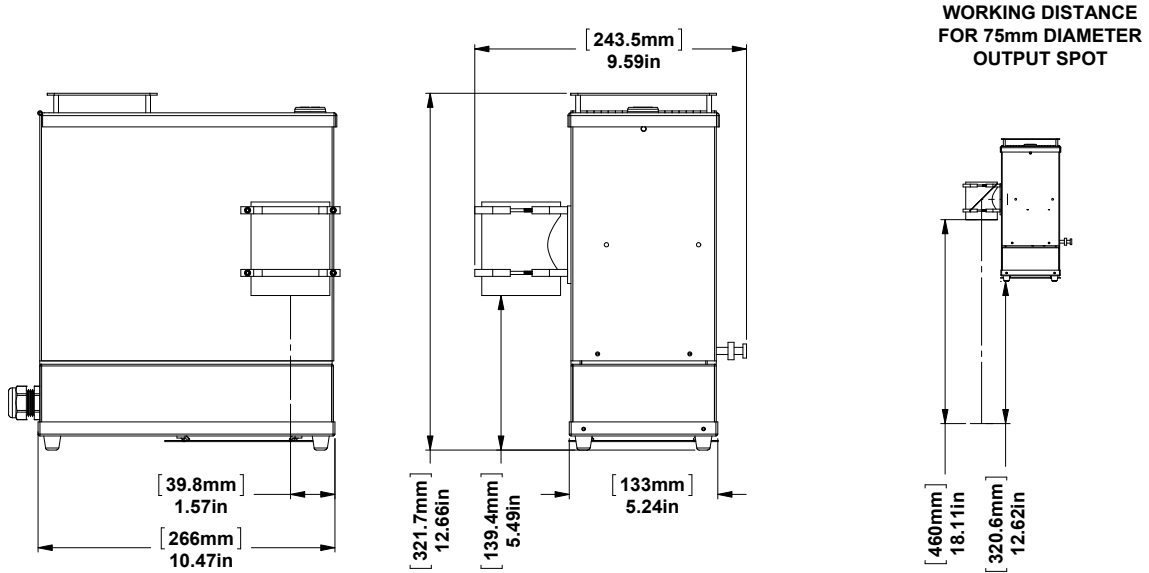

LS1000-Series 4 Inch (10 cm) UV Solar Simulator Outline Drawing

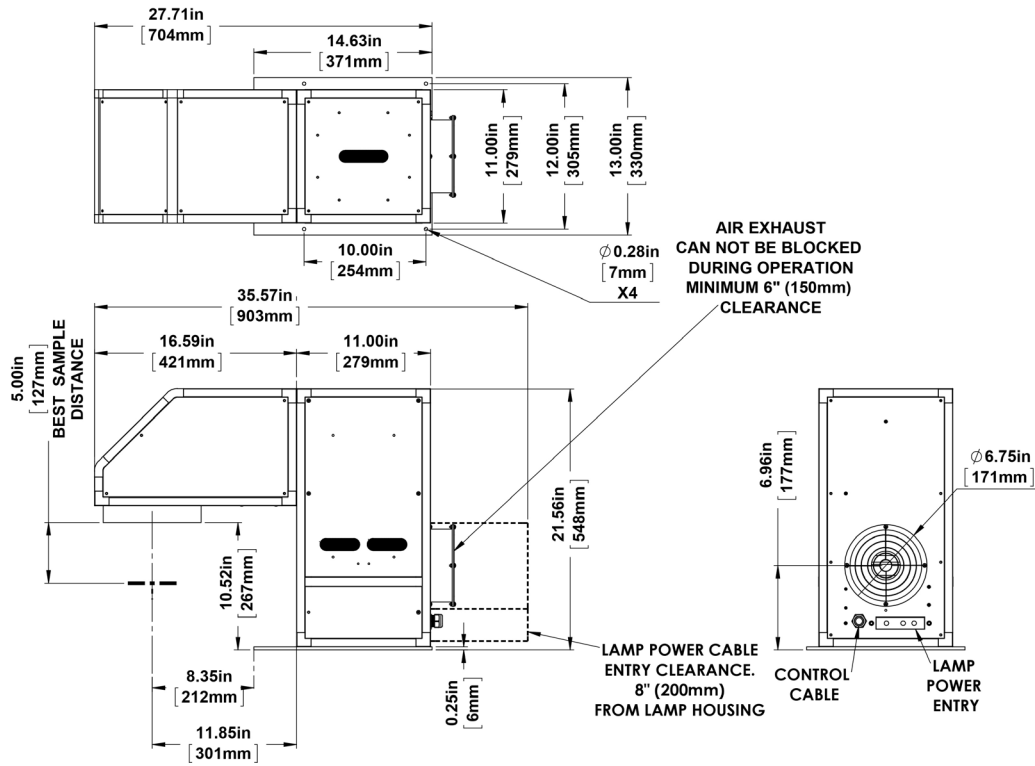

LS1000-Series 6 Inch (15 cm) UV Solar Simulator Outline Drawing

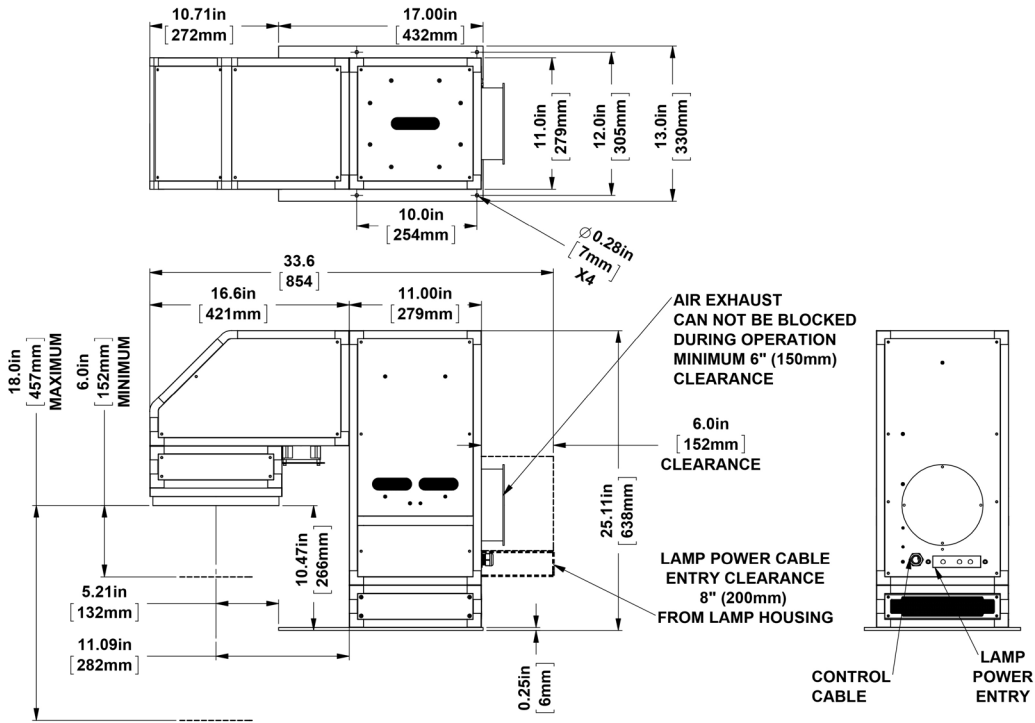

Since 1967, Solar Light Company, Inc. has been recognized worldwide as America's premier manufacturer of Precision Solar Simulators and Light Sources, Light Measurement Instrumentation, UV Transmittance Analyzers, Meteorological Instrumentation, and Digital and Analog Sensors. Our advanced line of UV, visible, and IR radiometers and light meters measure laboratory, industrial, environmental, and health related light levels with NIST traceable accuracy. Column ozone, aerosol, and water vapor thickness measurements, in addition to long-term global ultraviolet radiation studies all over the world are performed using our atmospheric line of instrumentation. Solar Light also provides NIST traceable spectroradiometric analyses, calibrations for light meters and light sources, accelerated ultraviolet radiation degradation testing of materials, and OEM instrumentation and monitors. Please visit our website for more details, specifications, and pictures!



State Of The Art Solar Simulators available in 150-1000+ watt UV or AM variations for a variety of applications including PV Cell Testing, Materials Testing, Pre-Irradiation for In Vitro Broad Spectrum Sunscreen Testing, SPF Testing, and much more.



Multi-Functional Professional Grade Radiometers available with and without data logging, and compatible with over 130 Solar Light PMA-Series Sensors to measure UV, Visible and IR wavelengths. Specialty Meters also available to measure UV Radiation, SUV/UVA, Scotopic/Photopic Spectra, and much more.



Advanced NIST-Traceable Sensors for accurate measurement of UVA, UVB, UVA+B, UVC, Visible, IR, Photostability, Temperature, and Custom Wavelength – well over 130 models in both digital and analog configurations, all compatible with our Radiometers.



Ultraviolet Transmittance Analyzers available as complete integrated turnkey systems to meet the latest ISO24443 requirements.



Handheld Ozonometers and Sunphotometers for fast and dependable Column Ozone, Aerosol, and Water Vapor Thickness measurements, in addition to long-term global ultraviolet radiation studies.



Compliant



Compliant



ISO 24443 Compliant



FDA In Vitro SPF



COLIPA Compliant



Boots Star Rated



Compliant



Compliant